



# HALLWAY COAT RAILS

**CLOAKROOM**  
SOLUTIONS



Including mounting material  
for wall fixing

Custom dimensions available.

Installation with hat rosette R40H:

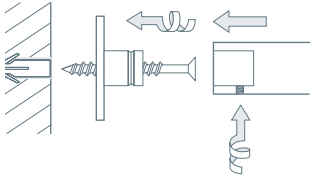

## HALLWAY COAT RAIL GL2-SR WITH INTEGRATED SHOE RACK

Hallway coat rails with integrated shoe rack, clothes rail and each two side coat hooks. With solid wall mounting. Solid stainless steel, hand-ground to a silky matt finish. Also available with an additional hat shelf made of glass or wood, see page 5 f.

### AVAILABLE PRODUCTS:

GL2-SR600

Total width 69cm.

GL2-SR800

Total width 89 cm.

GL2-SR1000

Total width 109 cm.

GL2-SR600/SR800/SR1000 Front View:

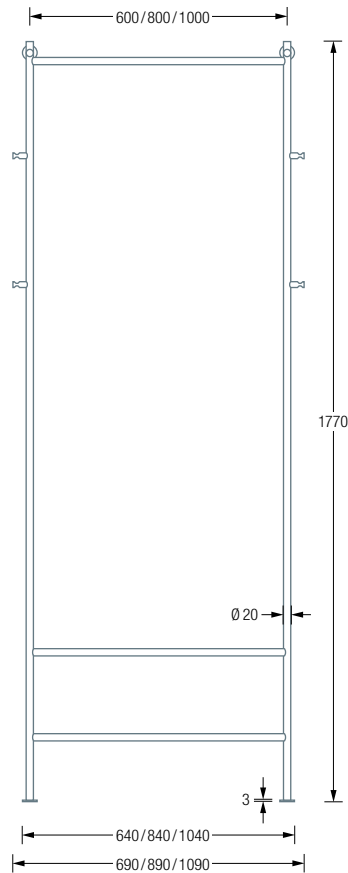

GL2-SR600/SR800/SR1000 Side View:

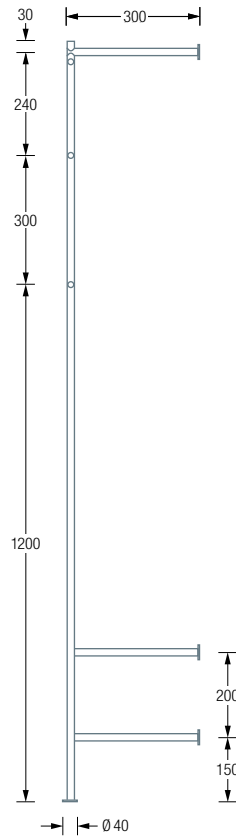



Including mounting material  
for wall fixing

Custom dimensions available.

Installation with hat rosette R40H:

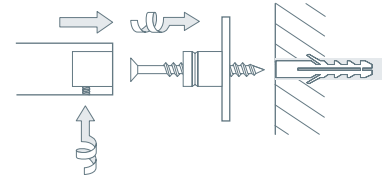

## HALLWAY COAT RAIL GL2G-SR WITH INTEGRATED SHOE RACK AND GLASS SHELF

Hallway coat rails with integrated shoe rack, clothes rail and two side coat hooks.  
With glass shelf made of 8 mm ESG (toughened safety glass, satin-finished underside), with rounded and polished edges. Including connection elements and four screws for flat screw connection. With solid wall mounting. Solid stainless steel, hand-ground to a silky matt finish.

### AVAILABLE PRODUCTS:

- GL2G-SR600** Total width 80cm
- GL2G-SR800** Total width 100 cm
- GL2G-SR1000** Total width 120 cm.

GL2G-SR600/SR800/  
SR1000 Front View:

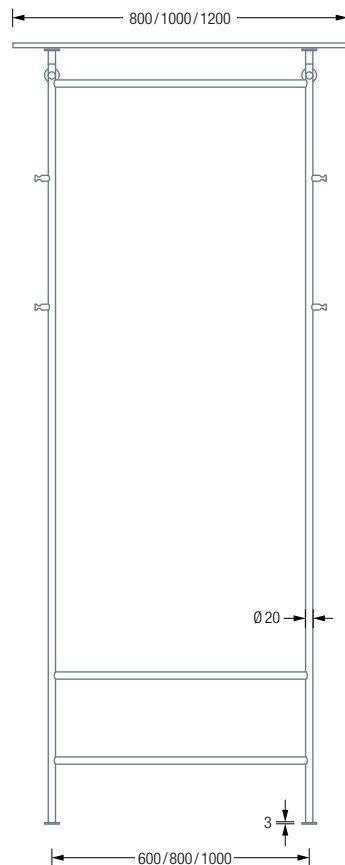

GL2G-SR600/SR800/  
SR1000 Side View:

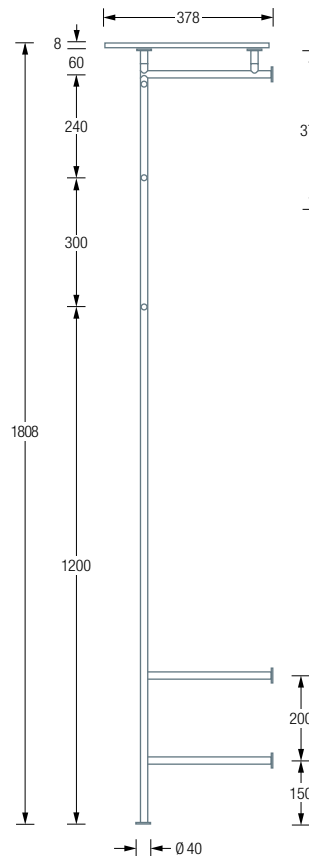

GL2G-SR600/SR800/  
SR1000 Top View:

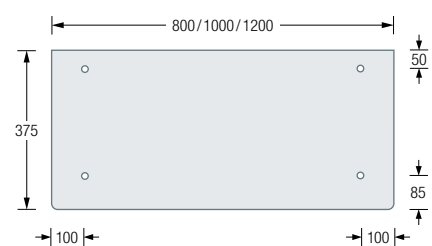



Including mounting material  
for wall fixing.

Custom dimensions  
available:

Installation with hat rosette R40H:

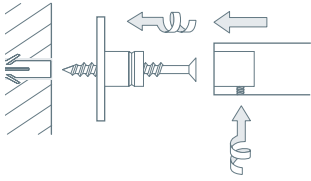

# HALLWAY COAT RAIL GL2-Oak-SR WITH INTEGRATED SHOE RACK AND OAK SHELF

Hallway coat rails with integrated shoe rack, clothes rail and two side coat hooks.  
With 19 mm solid natural oak shelf, oiled twice. Including connection elements and  
four screws for flat screw connection. With solid wall mounting. Solid stainless  
steel, hand-ground to a silky matt finish.

## AVAILABLE PRODUCT:

**GL2-Oak-SR600** Total width 80 cm.

**GL2-Oak-SR800** Total width 100 cm.

**GL2-Oak-SR1000** Total width 120 cm.

GL2-Oak-SR600/SR800/  
SR1000 Front View:

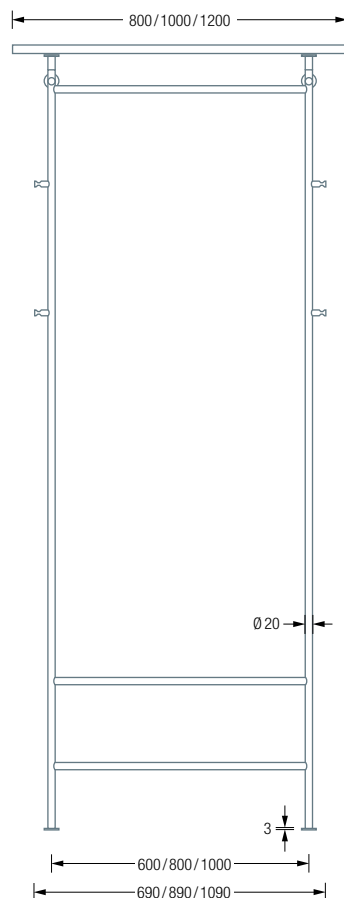

GL2-Oak-SR600/SR800/  
SR1000 Side View:

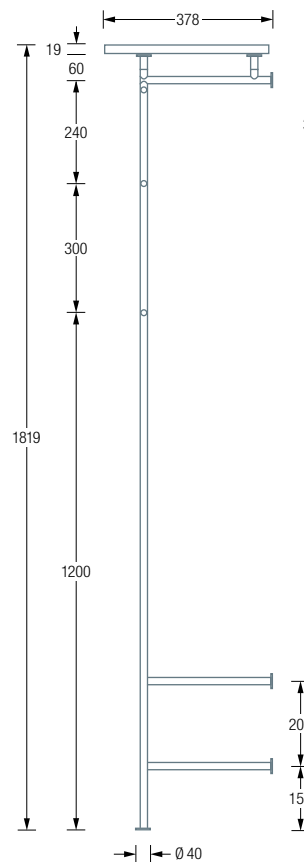

GL2-Oak-SR600/SR800/  
SR1000 Top View:

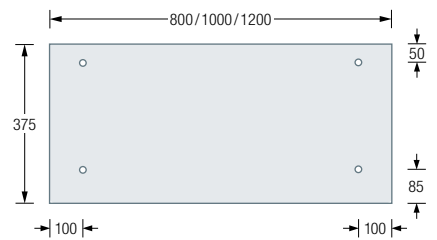





Including mounting material  
for wall fixing

Custom dimensions available.

Installation with hat rosette R40H:

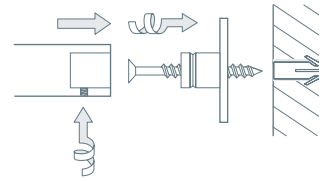

## HALLWAY COAT RAIL GL2

Hallway coat racks for wall and floor mounting with hat rosettes and Hilti fastening material\*. Two wardrobe elements, each with two side coat hooks, connected by a clothes rail. Solid stainless steel, hand-ground to a silky matt finish. Also available with an additional hat shelf made of glass or wood, see page 11 f.

### AVAILABLE PRODUCTS:

<b>GL2-600</b>	Total width 69 cm.
<b>GL2-800</b>	Total width 89 cm.
<b>GL2-1000</b>	Total width 109 cm.

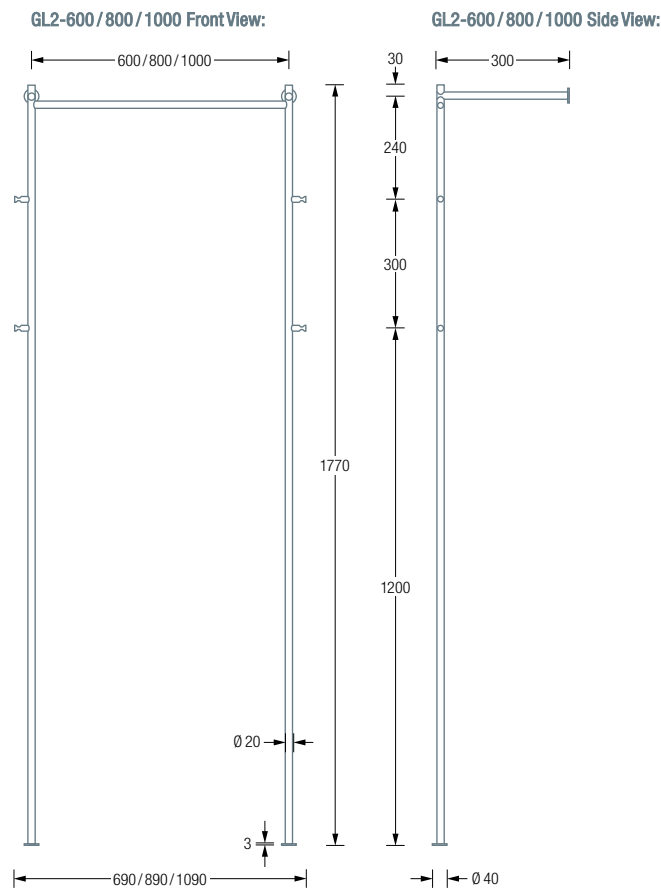

\* Stainless steel countersunk screw d 7 x 60 mm with frame dowel 10 mm (HRD-CR 10 x 60).



Custom dimensions available.

Assembly with glass shelf:

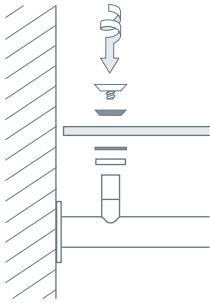

## HALLWAY COAT RAIL GL2G WITH GLASS SHELF

Hallway coat racks for wall and floor mounting with hat rosettes and Hilti fastening material\*. Two wardrobe elements, each with two side coat hooks, connected by a clothes rail. With glass shelf made of 8 mm ESG (toughened safety glass, satin-finished underside), with rounded and polished edges. Including connection elements and four screws for flat screw connection. Solid stainless steel, hand-ground to a silky matt finish.

### AVAILABLE PRODUCTS:

- GL2G-600** Total width 80 cm.
- GL2G-800** Total width 100 cm.
- GL2G-1000** Total width 1200 cm.

GL2G-600 / 800 / 1000 Front View:

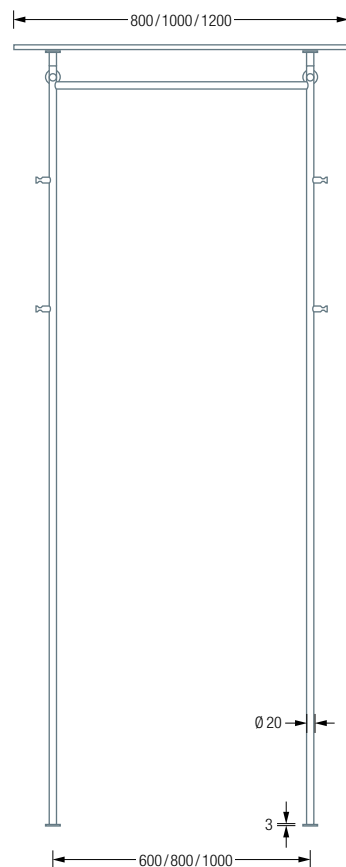

GL2G-600 / 800 / 1000 Side View:

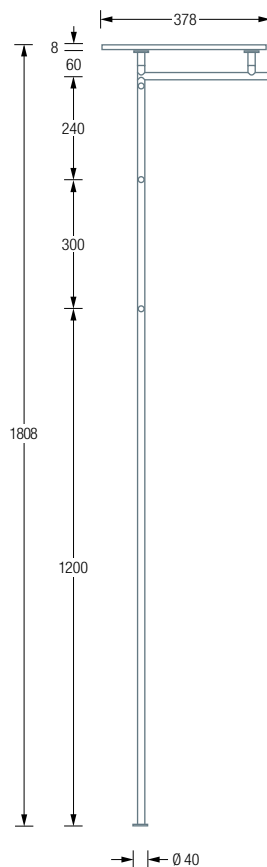

GL2G-600 / 800 / 1000 Top View:

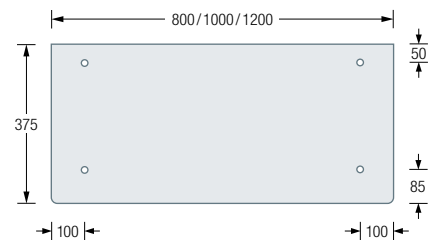

\* Stainless steel countersunk screw d 7 x 60 mm with frame dowel 10 mm (HRD-CR 10 x 60).



Assembly with wooden shelf:

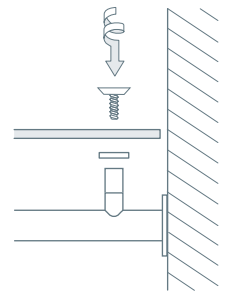

## HALLWAY COAT RAIL GL2-Oak WITH OAK SHELF

Hallway coat racks for wall and floor mounting with hat rosettes and Hilti fastening material\*. Two wardrobe elements, each with two side coat hooks, connected by a clothes rail. With 19 mm solid natural oak shelf, oiled twice. Including connection elements and four screws for flat screw connection. Solid stainless steel, hand-ground to a silky matt finish.

### AVAILABLE PRODUCTS:

<b>GL2-Oak-600</b>	Total width 80 cm.
<b>GL2-Oak-800</b>	Total width 100 cm.
<b>GL2-Oak-1000</b>	Total width 120 cm.

**GL2-Oak-600/800/  
1000 Front View:**

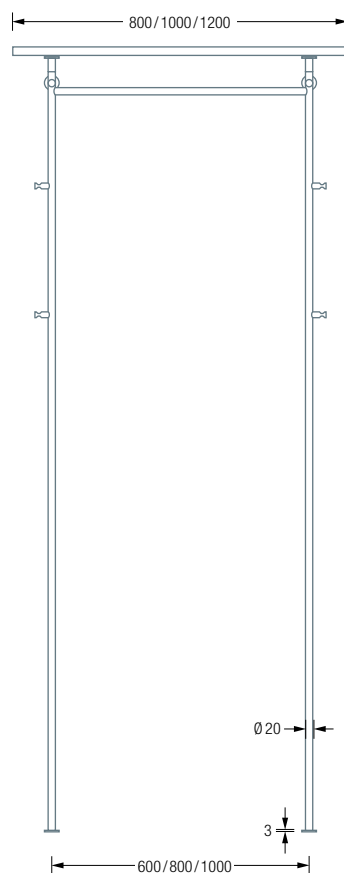

**GL2-Oak-600/800/  
1000 Side View:**

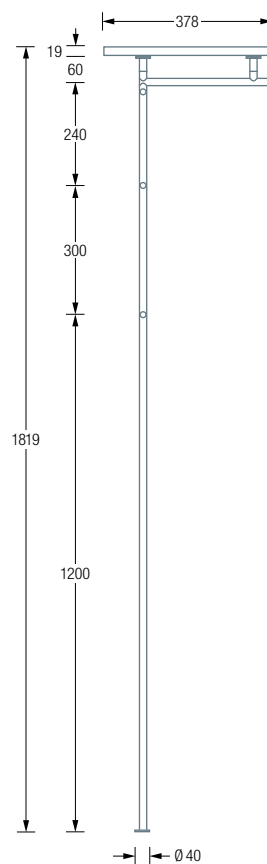

**GL2-Oak-600/800/  
1000 Top View:**

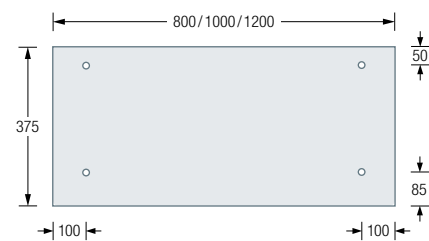

\* Stainless steel countersunk screw d 7 x 60 mm with frame dowel 10 mm (HRD-CR 10 x 60).





Glass shelf in clear glass on request.

## HALLWAY COAT RAIL GL1

L-shaped hallway coat rail for wall and floor mounting with hat rosettes and Hilti fastening material\*. An L-element leading to the wall with a clothes rail and four side clothes hooks. Solid stainless steel, hand-ground to a silky matt finish. Also available with a hat shelf made of glass or wood.

### AVAILABLE PRODUCT:

- GL1** Without hat rack.
- GL1G** With satin glass shelf made of 8 mm ESG (Toughened safety glass, satin-finished underside), with rounded and polished edges. Including connection elements and two screws for flat screw connection.
- GL1-Oak** With 19 mm solid wood natural oak shelf, oiled twice. Including connection elements and two screws for flat screw connection.

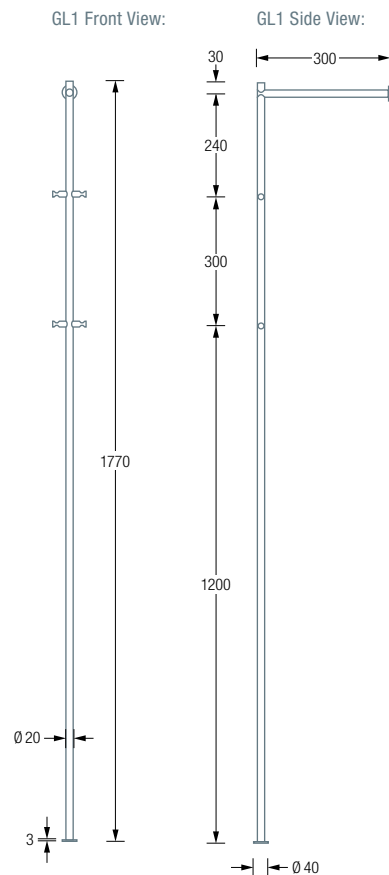
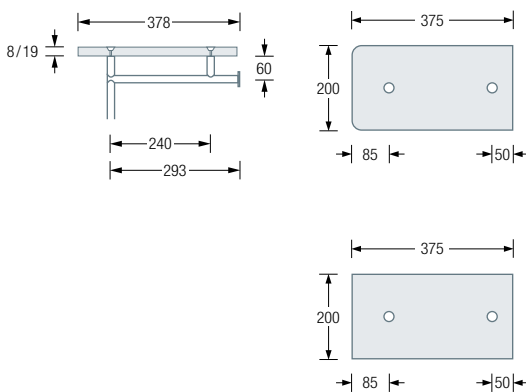

\* Stainless steel countersunk screw d 7 x 60 mm with frame dowel 10 mm (HRD-CR 10 x 60).





# HALLWAY COAT RAIL GL3

## AVAILABLE PRODUCT:

- GL3** L-shaped hallway coat rack for solid wall mounting with hat rosettes and Hilti fastening material\*. L-element with protruding clothes rail for clothes hangers and two rod-shaped clothes hooks. Solid stainless steel, hand-ground to a silky matt finish.

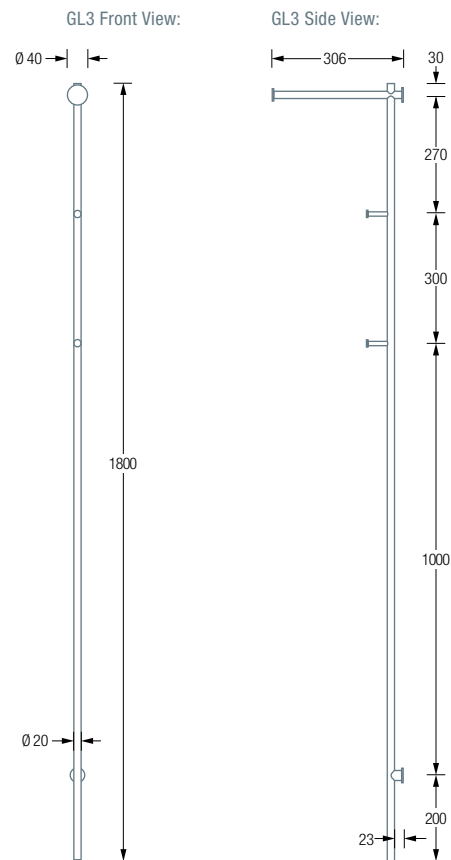

\* Stainless steel countersunk screw d 7 x 60 mm with frame dowel 10 mm (HRD-CR 10 x 60).



GT1 | KB1

## HALLWAY COAT RAIL GT1

### AVAILABLE PRODUCT:

- GT1** T-shaped hallway coat rack for wall mounting. With transverse clothes rail, ends with hook pins. With solid wall mounting. Solid stainless steel, hand-ground to a silky matt finish.

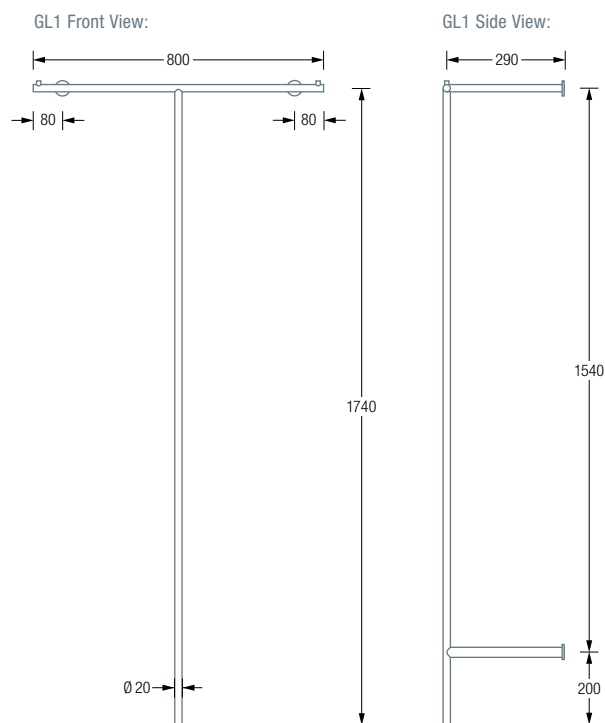

Including mounting material for wall fixing.

Installation with hat rosette:

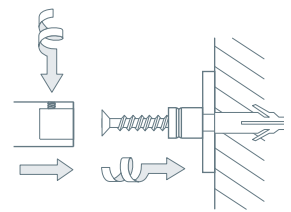



GT | KB1

## HALLWAY COAT RAIL GT CORNER LEANING RAIL

### AVAILABLE PRODUCT:

**GT** T-shaped leaning wardrobe. Solid stainless steel, hand-ground to a silky matt finish. Portable wardrobe for corners of rooms. Installation without drilling.

GT Front View:

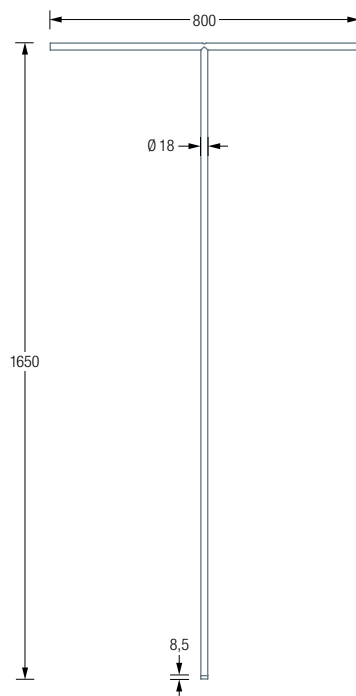



## CLOTHES HOOKS

Clothes hooks for threading and securing to clothes rails. Includes black protective cap\*. Solid stainless steel, ring element hand-ground.

### AVAILABLE PRODUCT:

- HK12** For Stainless steel rods  $\varnothing 12$  mm.
- HK16** For Stainless steel rods  $\varnothing 16$  mm.
- HK18** For Stainless steel rods  $\varnothing 18$  mm.
- HK20** For Stainless steel rods  $\varnothing 20$  mm.

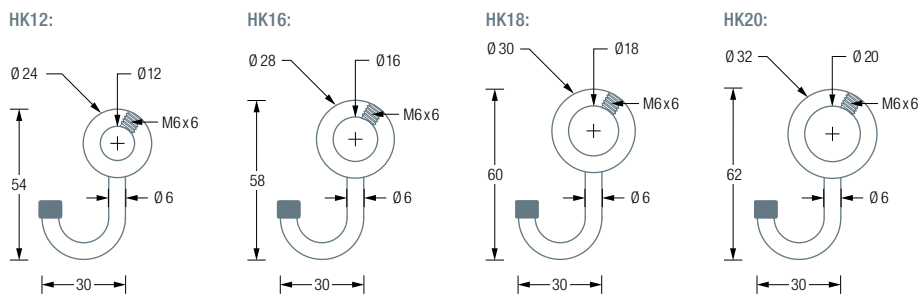

- HKS** S-hook for stainless steel rods up to  $\varnothing 20$  mm.
- HKC** C-hook for stainless steel rods up to  $\varnothing 18$  mm.

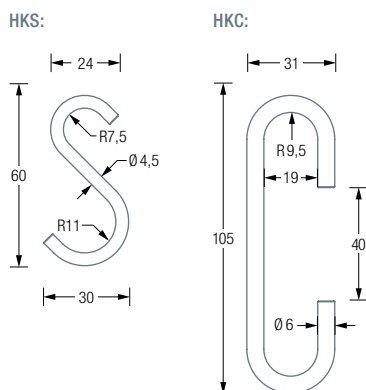

\*Material: PE (polyethylene), matt black. High chemical resistance, good lubricity.



KB1H



KB1G

## COAT HANGERS

Clothes hanger with concealed 360° rotation mechanism and elegant connection detail without visible screw connection. Stainless steel, solid material Ø 10 mm, brushed silky matt.

### AVAILABLE PRODUCT:

- KB1** Coat hanger.
- KB1H** Coat hanger with trouser bar.
- KB1G** Coat hanger for public areas with closed eye (theft protection).
- KB1HG** Coat hanger with trouser bar for public areas with closed eye (theft protection).

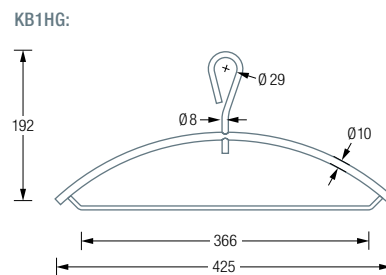
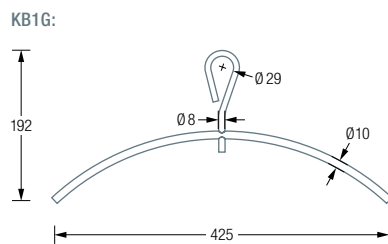
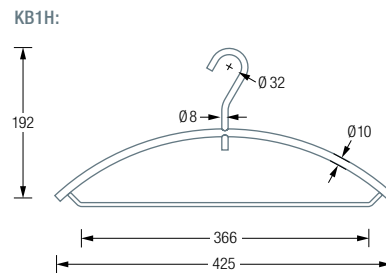
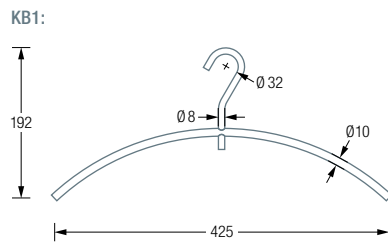





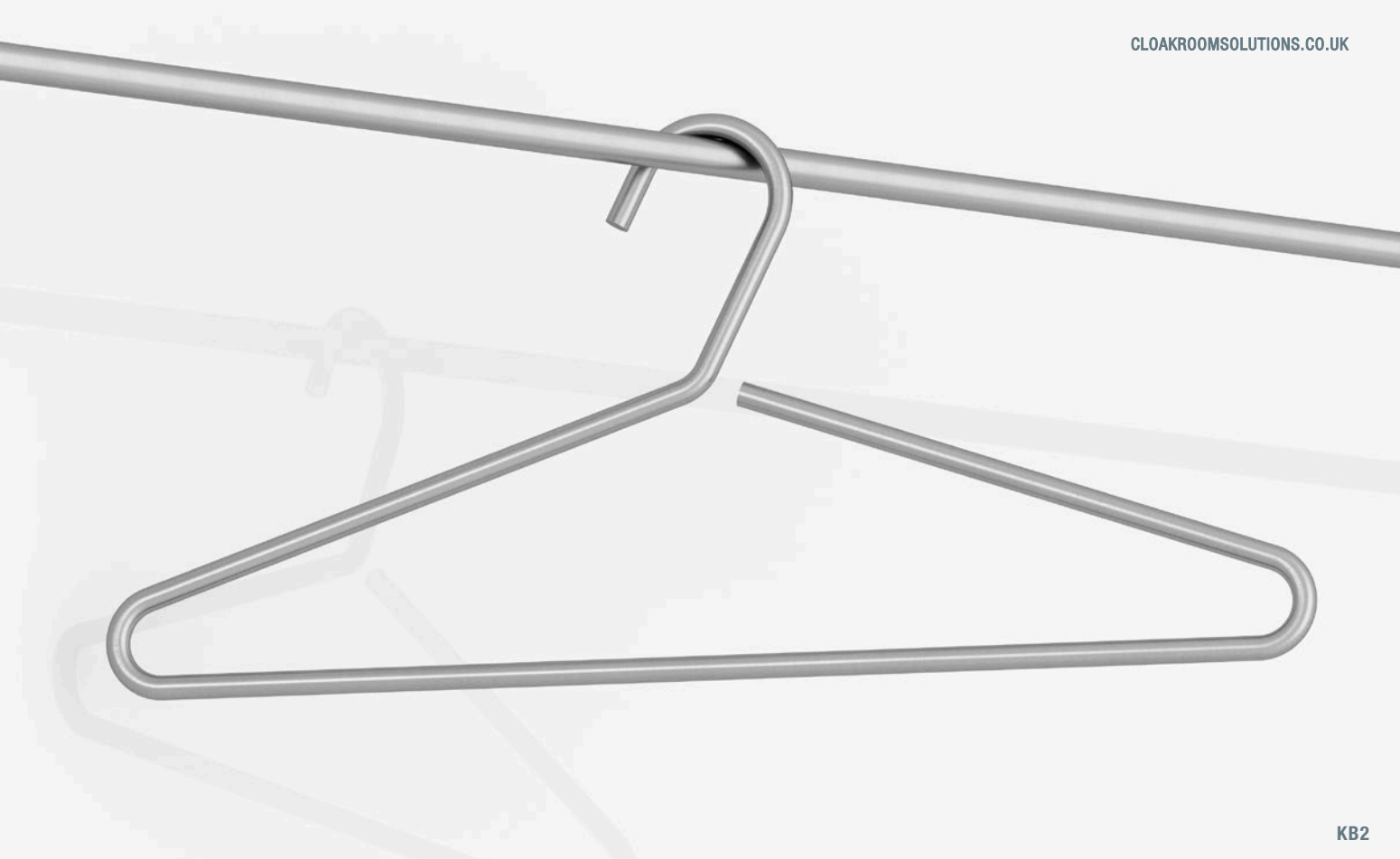

KB2

## COAT HANGER

**KB2** Coat and trouser hangers made from one piece.  
Stainless steel, solid material  $\varnothing$  8 mm, brushed silky matt.

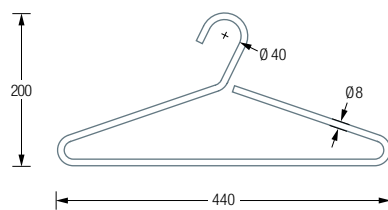



CLOAKROOM SOLUTIONS LTD  
info@cloakroomsolutions.co.uk  
020 3011 1014  
cloakroomsolutions.co.uk