

CONTI lino lavatory faucet L20

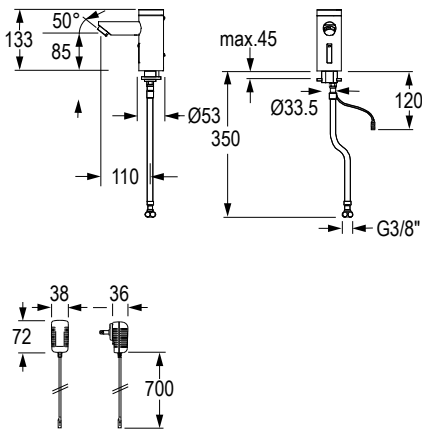

lino lavatory faucet L20, with IR sensor, without temperature-mixing (for cold or premixed water), chromed

Touchless, electronically controlled lavatory faucet:

- Modular single-piece design without separate installation box, sturdy brass housing, chromed
- Infrared sensors with automatic setting feature, microprocessor
- Reliable solenoid valve ROBUST (minimal level of water pressure surge) and economic aerator
- Cold water supply connection with flexible hose, built-in filter
- Temporary-off (cleaning) and continuous water flow time (filling of basin) activated by Click-plus
- Continuous water flow time and hygienic flush time adjustable with function key
- Follow-up time and sensor sensitivity adjustable with function key
- 12, 24 or 48-hour hygienic flush activatable with function key
- Installation similar to conventional single-lever faucet
- Compatible with CNX and Service APP: control of stored operational data, settings and control functions

Click: Recessed function key - without additional functions
 Click-plus: Protruding function key Click-plus (continuous-on, temporary-off)
 Battery: 6 V Lithium CRP2 - commercial; life time up to 4 years
 Solar: Photovoltaic cells with 6 V Lithium CRP2 (support batteries) commercial - life-time up to 6 years
 Mains supply: Plug-in transformer 110-240 V 50/60 Hz / 6 V
 VARIOconnect: For single and multiple power supply and data connection (Connection CNX and Service APP - see accessories)

Operating pressure: 0,3-10 bar
 Flow rate: Approx. 6 l/min / 1,6 gpm (3 bar)
 Water temperature (max.): 80 °C
 Aerator: Economic aerator, CASCADE (self-cleaning)
 Flexible hose: 350 mm
 Angle valve connection: G 3/8
 Built-in filter: 0,5 mm mesh size
 Sensor sensitivity: Automatic self-adapting sensor technology
 Follow-up time: 1 s pre-set (adjustable with function key 0-10 s)
 Continuous water flow and hygienic flush time: 2 min pre-set (adjustable with function key 0,5-20 min)
 Temporary-off: 2 min (fixed)
 Engineering standards: DIN EN 200; Noise class I; P-IX 9575 / IA; C€

Optional: Extension kit for countertop basins (see accessories)

Note: When integrated into the CNX Water Management System, the CNX Converter 6 V must be ordered separately.

When using the Service APP, the BLE Converter must be ordered separately.

Versions		Function key Click-plus	Function key Click
Power supply	Drain assembly	Article number	Article number
Battery	Without	120.140.11	120.040.11
Mains operation	Without	120.150.11	120.050.11
VARIOconnect	Without	120.156.11	120.056.11
Solar	Without	120.148.11	120.048.11

CONTI  lino lavatory faucet L20

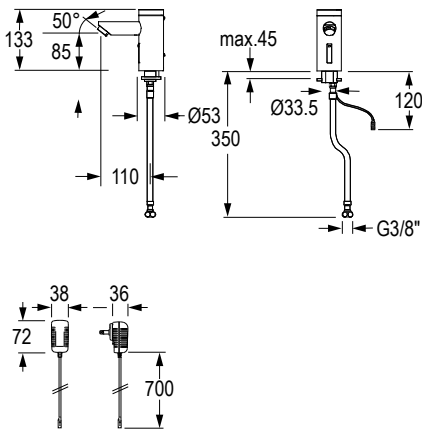

lino lavatory faucet L20, with IR sensor, without temperature-mixing (for cold or premixed water), PVD











Touchless, electronically controlled lavatory faucet:

- Modular single-piece design without separate installation box, sturdy brass housing, PVD
- Infrared sensors with automatic setting feature, microprocessor
- Reliable solenoid valve ROBUST (minimal level of water pressure surge) and economic aerator
- Cold water supply connection with flexible hose, built-in filter
- Continuous water flow time and hygienic flush time adjustable with function key
- Follow-up time and sensor sensitivity adjustable with function key
- 12, 24 or 48-hour hygienic flush activatable with function key
- Installation similar to conventional single-lever faucet
- Compatible with CNX and Service APP: control of stored operational data, settings and control functions

Click: Recessed function key - without additional functions
 Battery: 6 V Lithium CRP2 - commercial; life time up to 4 years
 Mains supply: Plug-in transformer 110-240 V 50/60 Hz / 6 V
 VARIOconnect: For single and multiple power supply and data connection (Connection CNX and Service APP - see accessories)

Operating pressure: 0,3-10 bar
 Flow rate: Approx. 6 l/min / 1,6 gpm (3 bar)
 Water temperature (max.): 80 °C
 Aerator: Economic aerator, CASCADE (self-cleaning)
 Flexible hose: 350 mm
 Angle valve connection: G 3/8
 Built-in filter: 0,5 mm mesh size
 Sensor sensitivity: Automatic self-adapting sensor technology
 Follow-up time: 1 s pre-set (adjustable with function key 0-10 s)
 Continuous water flow and hygienic flush time: 2 min pre-set (adjustable with function key 0,5-20 min)
 Temporary-off: 2 min (fixed)
 Engineering standards: DIN EN 200; Noise class I; P-IX 9575 / IA; C E

Note: When integrated into the CNX Water Management System, the CNX Converter 6 V must be ordered separately.
 When using the Service APP, the BLE Converter must be ordered separately.

Version		Function key Click 	
Stromversorgung	Drain assembly	Colour	Article number
 Battery	Without	 Brushed nickel	120.040.01
		 Polished brass	120.040.22
		 Brushed chrome	120.040.44
 VARIOconnect 	Without	 Brushed nickel	120.056.00
		 Polished brass	120.056.22
		 Brushed chrome	120.056.44

CONTI  Accessories lino lavatory faucets

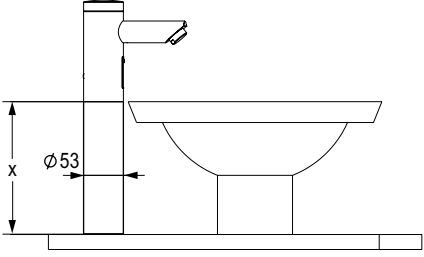
		<p>Faucet extension for lino lavatory faucets</p> <p>Extension suitable for L10, L13, L20, L10i</p> <ul style="list-style-type: none"> ▲ One-piece design without concealed parts ▲ Sturdy brass, chromed <p>Set consisting of:</p> <ul style="list-style-type: none"> ▲ Extension ▲ Threaded rod ▲ Connection hoses and filters <p>Only for faucets without drain assembly!</p>	
Description	Length (x)	Colour	Article number
Faucet extension lino	177 mm	Chromed	550.034.11
	56 mm	Chromed	550.034.12